

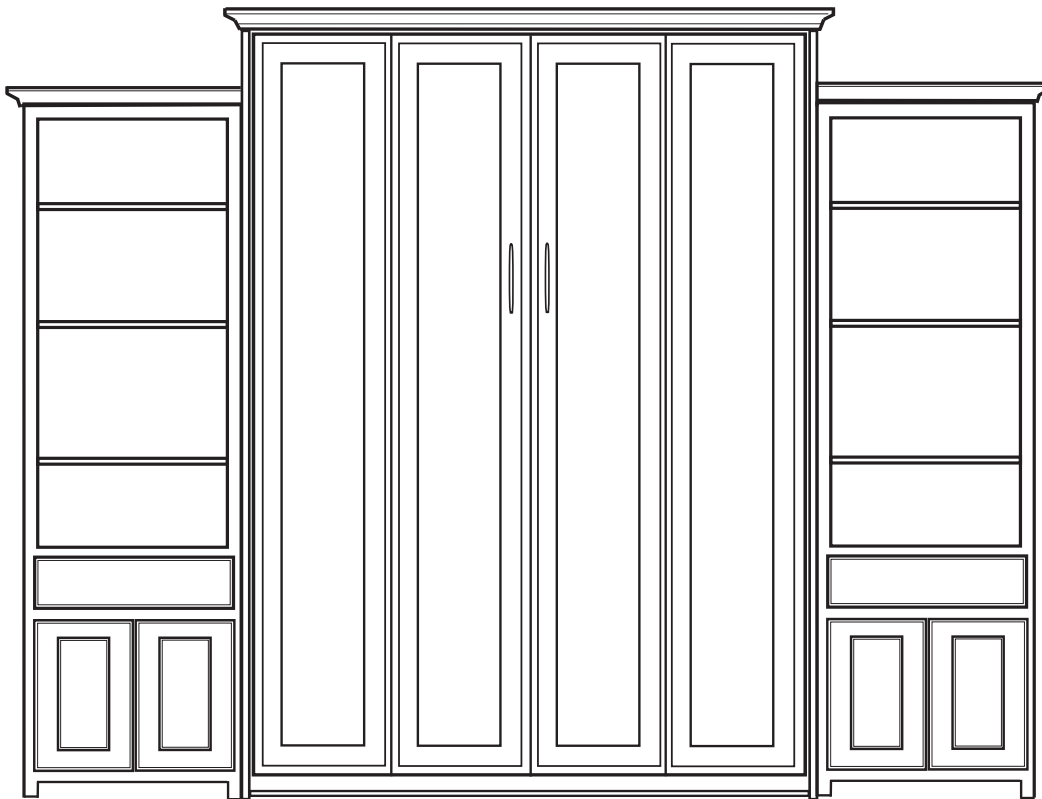

Wilding Wallbeds®



STORAGE HEAD BOARD

INSTRUCTION BOOKLET #C23

Watch step by step installation instructions at:

<https://www.wallbedsbywilding.com/wallbed-installation-studio-series/>

WARNING! ALL MURPHY/WALLBED SYSTEMS CONTAIN STORED ENERGY. FAILURE TO USE AND FOLLOW THESE INSTRUCTIONS DURING THE INSTALLATION PROCESS COULD RESULT IN SEVERE PERSONAL INJURY TO USER OR DAMAGE TO PRODUCT. PLEASE CONTACT CUSTOMER SERVICE AT 866-725-6401 FOR ANY QUESTIONS.

Tools Needed

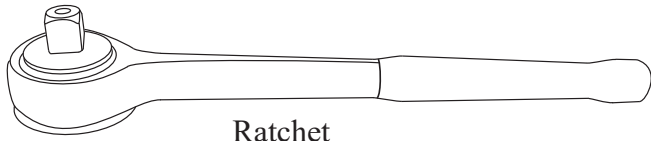

Ratchet



13mm Socket



11mm Socket



8mm Socket

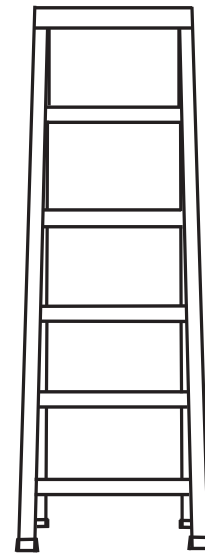

6 foot ladder



Phillips screwdriver

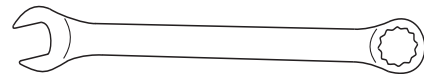

13 mm open end wrench

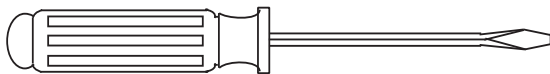

Large regular screwdriver

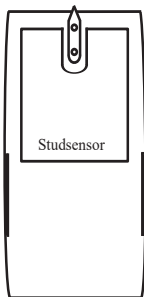

Stud finder

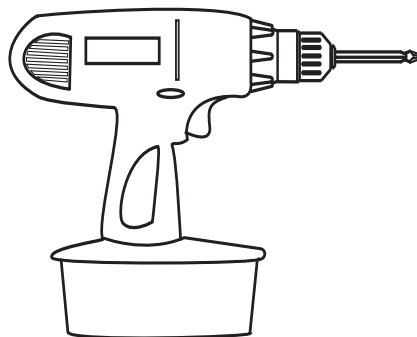

Cordless screw driver
With Phillips bit

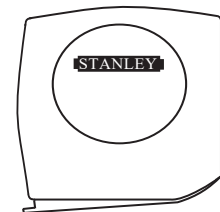

Tape measure

Hardware Page

Pack 2

Item Qty



16

5/16" Nylock
Hex Nut

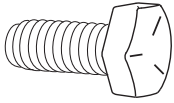

4

5/16" x 1"
Hex Head Bolt

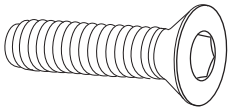

10

5/16" x 1 1/4"
Tapered Allen Head Bolt

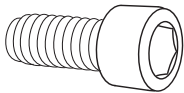

2

5/16" x 1"
Allen Head Bolt



2

1 5/8" Pan head
Wood Screw

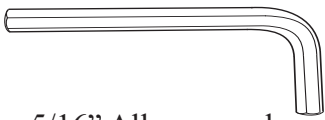

5/16" Allen wrench

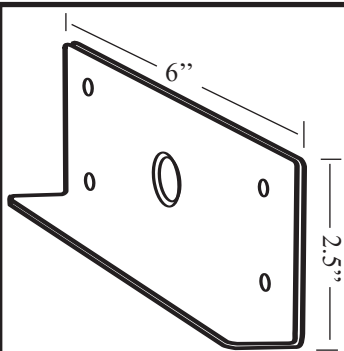

2

Panel Saver
(In mechanism rails box)

Pack 3

Item Qty



16

10-24 Black
Nylock Nut

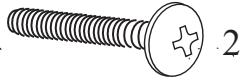

2

10-24 x 1 1/4" Black
Machine Screw

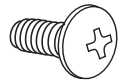

14

10-24 x 1/2" Black
Machine Screw

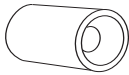

2

1/2" x 3/4"
Black Barrel
(Leg Stop)

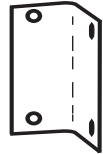

4

1" x 1" x 1 3/4"
Four Hole Corner
Bracket

Pack 4

Item Qty



2

Star Washer

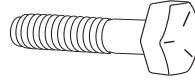

2

1/4" x 1 1/2"
Hex Head Bolt

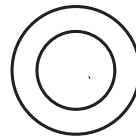

4

1 1/2" Nylon washer

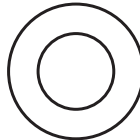

2

1 1/2" x 5/16"
Black washer

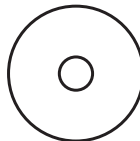

2

1 1/2" X .765"
Black washer

Other Hardware

(From Manila Envelope)

Item Qty

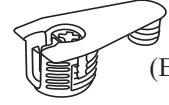

4
(Extra)

Cam Fitting



1

Square Tip Bit



34

Connecting Bolts

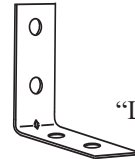

3

"L" Bracket

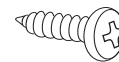

6

5/8" Pan head Screw

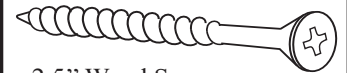

6

2.5" Wood Screw



10

1 1/4" Wood Screw

Pack 7

Item Qty

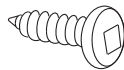

160

5/8" Pan
head Screw

Pack 5

Item Qty

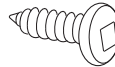

2

5/8" Pan head Screw



2

3/4" Washer

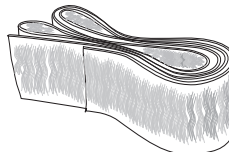

2

Velcro Retainer Straps

Bed Handles



Bed Models

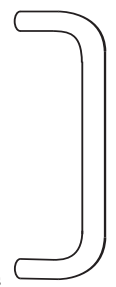

Dakota



4

1 3/8"

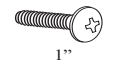

4

1"

NOTE: Handle may vary depending on bed style.

Step 1: Locate the two Side Boards. If you purchased a King or Queen size bed the Side Boards measure 85.25" long. Then from the small square cardboard box labelled SBLM, locate the two Lift Mechanisms, hardware bags, and springs.

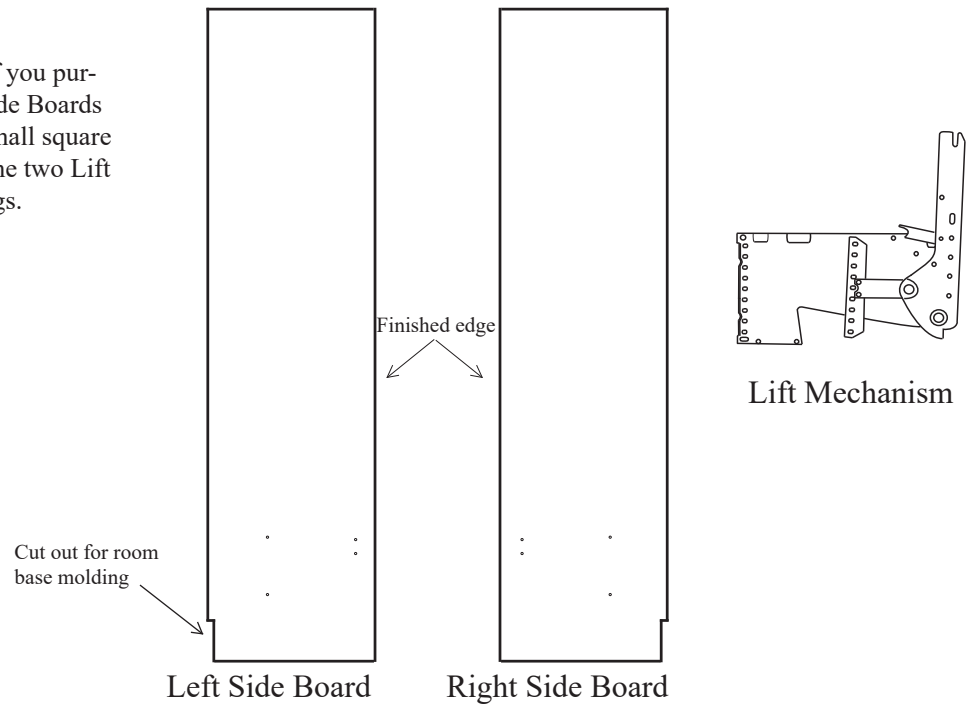

Hardware needed for next step from Pack #2

 x 8
5/16" Nylock Nut

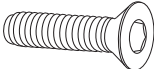
 x 8
5/16" x 1 1/4"
Tapered Allen Head Bolt

Step 2: Install the Lift Mechanism to the right Side Board first by inserting a 5/16 x 1 1/4" Tapered Allen head Bolt through holes A, B, C and D from the outside (countersunk holes) of the Side Board. The bolt then goes through the corresponding holes of the Right Lift Mechanism as illustrated. Thread on four 5/16" Nylock nuts and tighten hardware. (hole A may have threaded collar instead of bolt)

IMPORTANT! Over tightening the nuts will pull the head of the bolt too deeply into the Side Board. Tighten only until the head of the bolt is flush with the surface of the Side Board .

Repeat step 2 with the Left Side Board and Lift Mechanism.

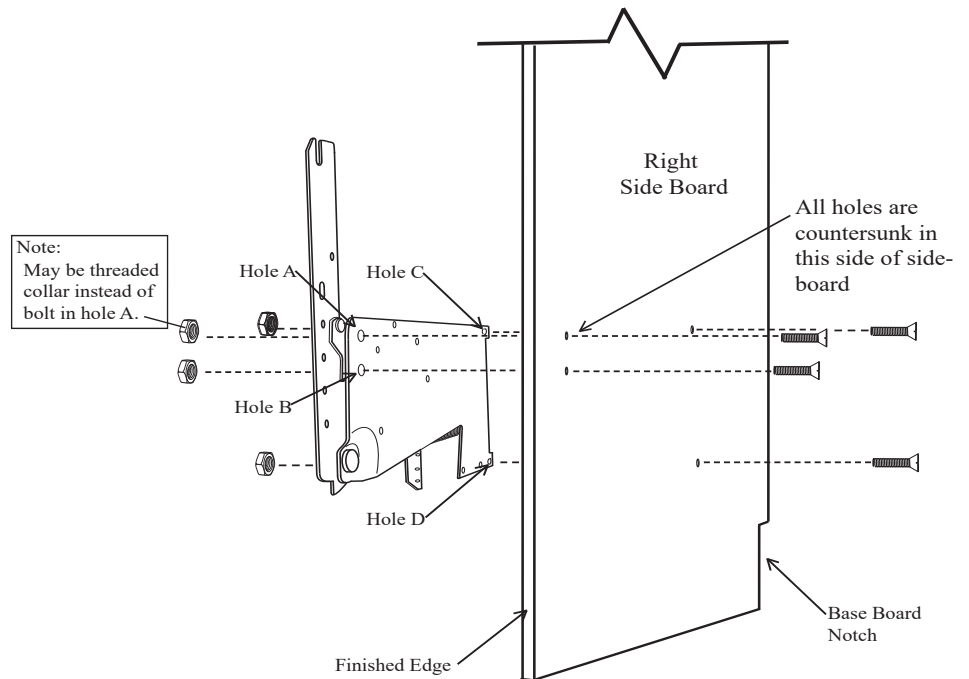

Hardware needed for next step:



Lifting Springs

(from box labelled SBLM)

Step 3: Install Springs in the Lift Mechanisms (Some springs may be pre-installed)

The required number of springs in the Lift Mechanisms varies with the different weights of mattresses. If you purchased your mattress with your bed from Wilding Wallbeds refer to the chart to the right. This will also be a good reference point for mattresses not purchased with your Wall bed.

Bed Size	Number of Springs
Queen	7
Full/Double	6
Twin/Single	4

NOTE: After you have completed installing and checking operation of your Wall bed, you may find it necessary to add or remove springs to achieve the correct lift effort of between 5 and 10 pounds.

- Install the first spring in hole #5 (if mechanism has some pre-loaded springs from the factory, remove lower springs first) on both the Mounting Plate and the Tension Arm. Hook one end of the spring under the upturned edge of the Mounting Plate first then lay the spring down and slide it under the matching hole in the Tension Arm. See illustration 1.

HELPFUL HINT: Watch how to do this process at:

<https://www.wallbedsbywilding.com/wallbed-installation-studio-series/>

See [step 4](#) of the video to view installation of springs.

- Continue by working up one hole in the lifting mechanism, then down one hole alternating back and forth until all springs are loaded.

IMPORTANT! Be sure that holes of the Mounting Plate correspond to the holes in the Tension Arm and use the same number of springs and the same configuration on both Lift Mechanisms

- Repeat Step 3 for Left Lift Mechanism.

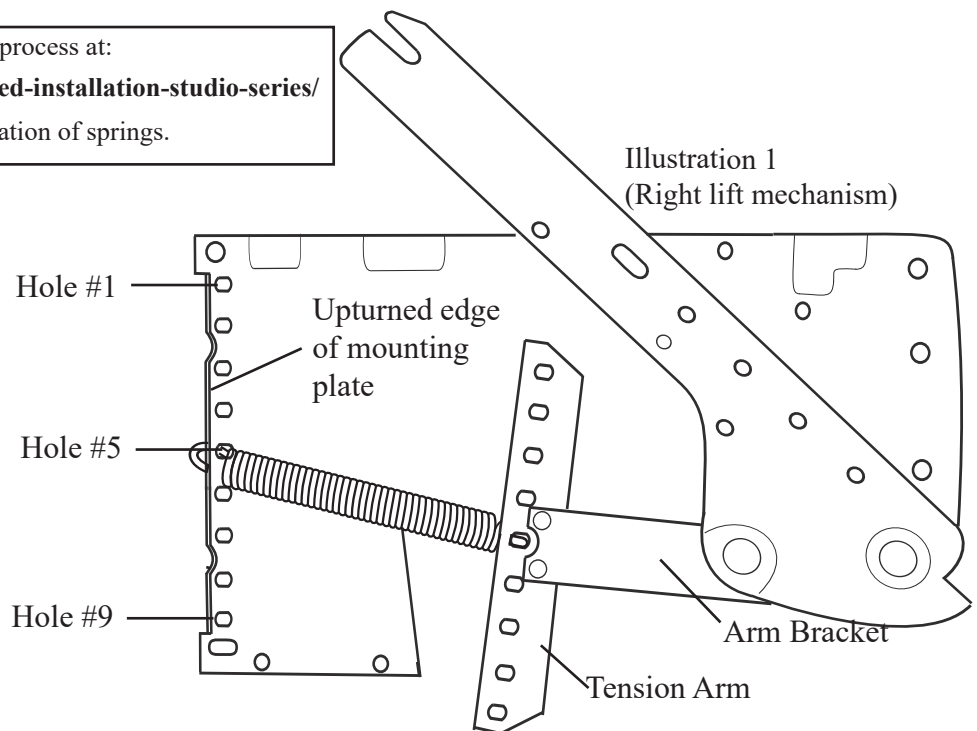

Hardware needed for next step:

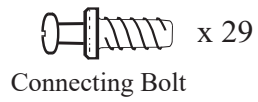

(From Manila Envelope)

Step 4: Lay the right Side Board down and screw 14 Connecting Bolts into the holes provided as shown. Repeat the process with the left Side Board which will require 15 Connecting Bolts.

Note: Screw the connecting bolts down until the collar of the connecting bolt is seated firmly against the surface of the wood.

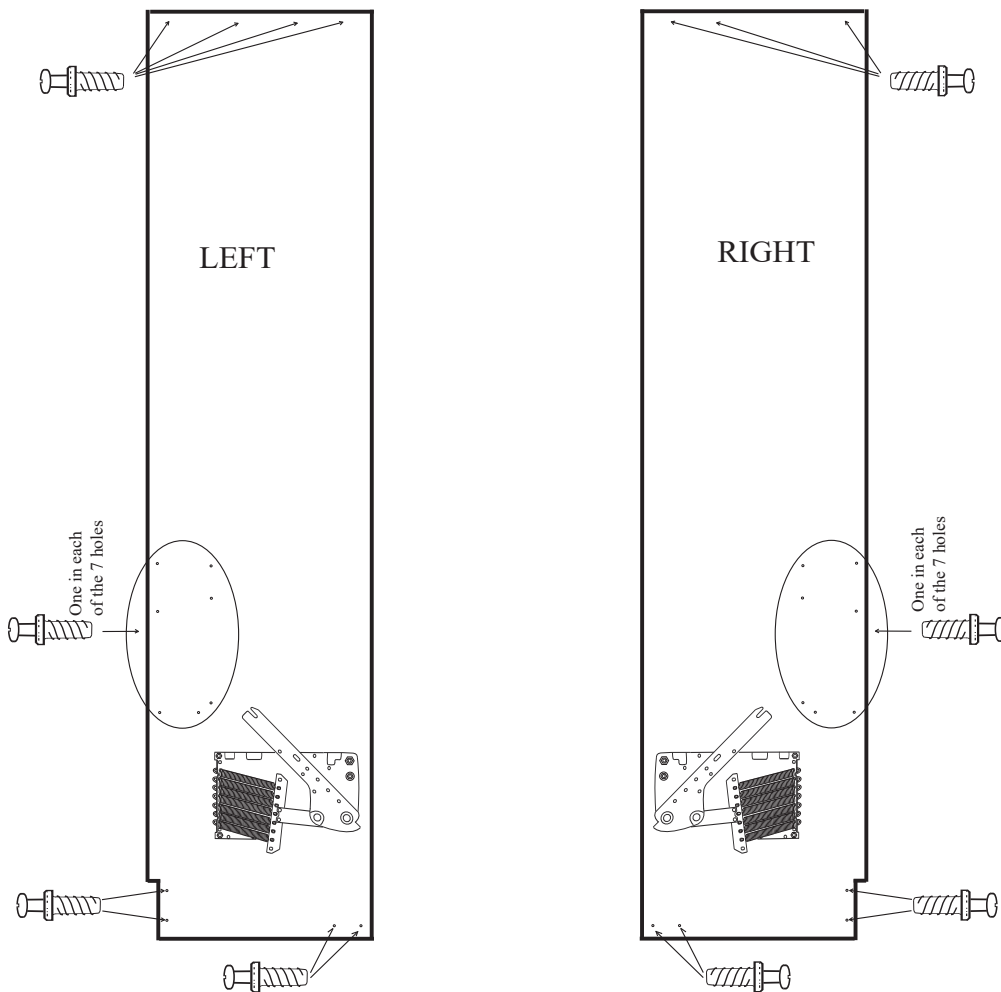

Hardware needed for next step:  x 3 (From Manila Envelope)
Connecting Bolt

Storage Head board Steps

Storage Head board step A: Locate the Head Board and insert 3 Connecting Bolts into the holes at the bottom edge of the Head Board.

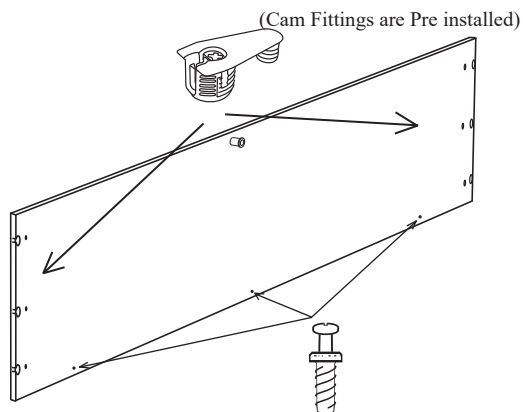

Storage Head board step B: Identify the Head Board Bottom which has 7 Cam fittings pre-installed and a grommet hole in the center.

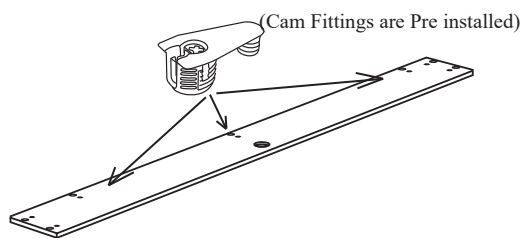

Working with Cam Fittings

In the next three steps you will work with Cam Fittings and Connecting Bolts in attaching cabinet parts together. Take a minute and review this information for ease of assembly.

- Slide the Cam over Connecting bolt.
- Hold parts snug together.
- Turn Cam Fitting 1/2 turn clockwise with a manual screw driver. **DO NOT USE POWER SCREW DRIVER.**

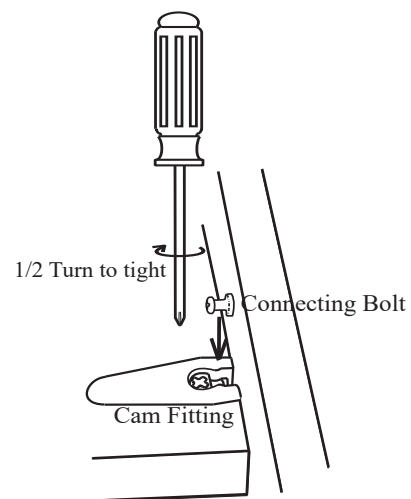

Step 5: Assemble the Bed Cabinet face down with the bottom of the Bed Cabinet nearer the wall to which it will be installed. Note the “Front Stretcher” (illustrated to right) should be positioned so the Cam Fittings are at the bottom of the Bed Cabinet.

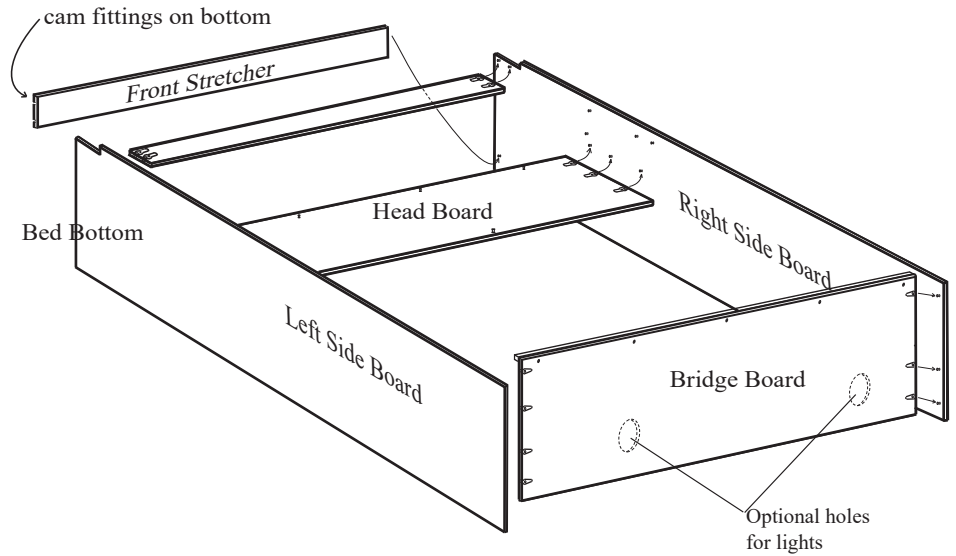

Storage Head board steps

Storage Head Board Step C: Insert the Head Board bottom into position as illustrated. Note the cam fittings are facing down toward the bottom of the bed cabinet.

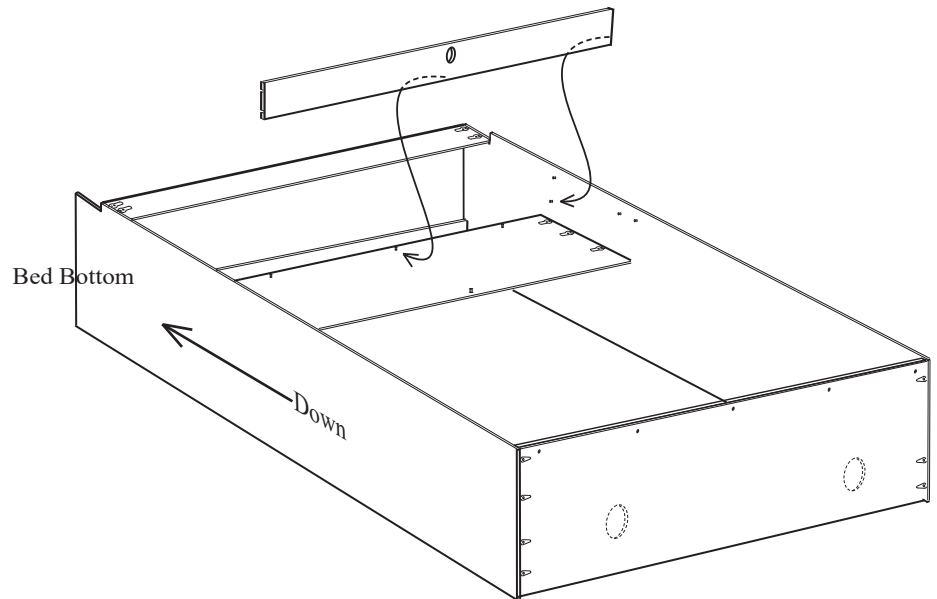

Storage Head Board Step D: Install the hinged storage door unit as illustrated.

Helpful hint: Lift the center section of the hinged storage door to get the unit positioned correctly.

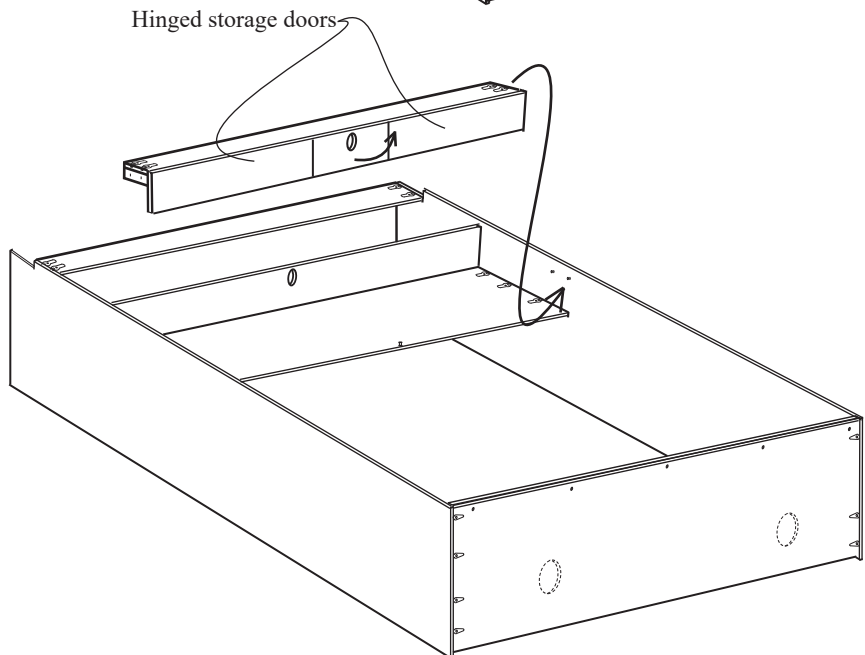





IF YOU PURCHASED LIGHTS FOR YOUR WALLBED YOU MUST REFER TO THE LIGHT KIT INSTRUCTIONS AND INSTALL THE LIGHT KIT BEFORE MOVING ON.

(Light Kit instructions are in the Light Kit box)

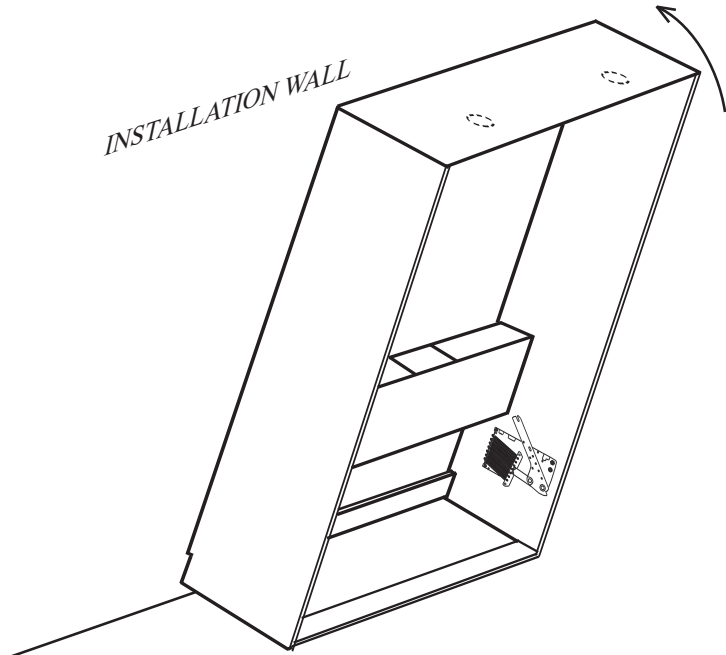
Step 6: Stand the Bed Cabinet up against the wall where you intend to have it installed.



Hardware needed for next step

 X 4 (From Manila Envelope)
1 1/4" Wood Screw

Storage Head board step

Storage Head Board Step

E: With Bed Cabinet in the standing position open the storage head board on both sides and insert two 1 1/4" screws in either side of the lid support through holes provided as shown.

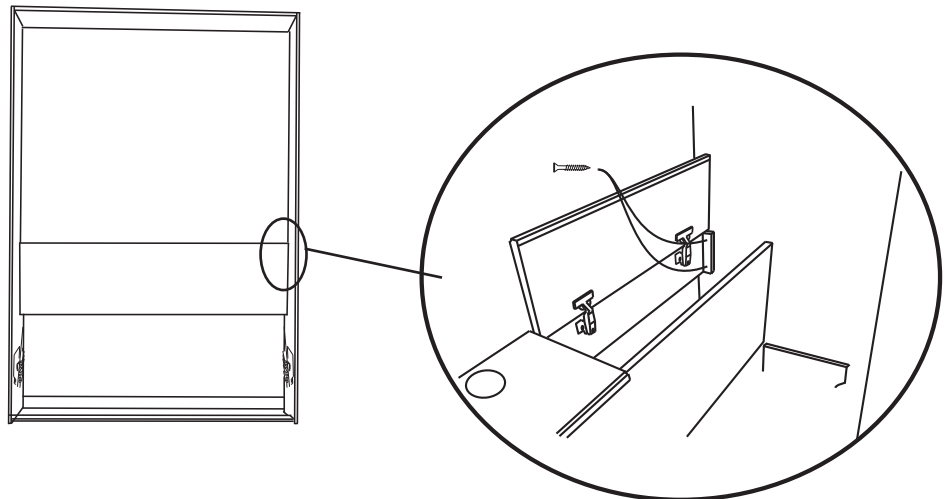

WARNING! THE NEXT STEP MAY REQUIRE PROFESSIONAL HELP.

IF YOUR WALLS ARE NOT TRADITIONAL WOOD FRAMING, YOU MAY NEED TO HIRE A HANDY MAN OR CONTRACTOR TO HELP IN ANCHORING THE BED TO YOUR WALL. FAILURE TO PROPERLY ANCHOR CABINET COULD CAUSE SEVERE PERSONAL INJURY. CALL TECHNICAL SUPPORT AT 866-725-6401 IF YOU HAVE ANY QUESTIONS.

Hardware needed for next step
(From Manila Envelope)

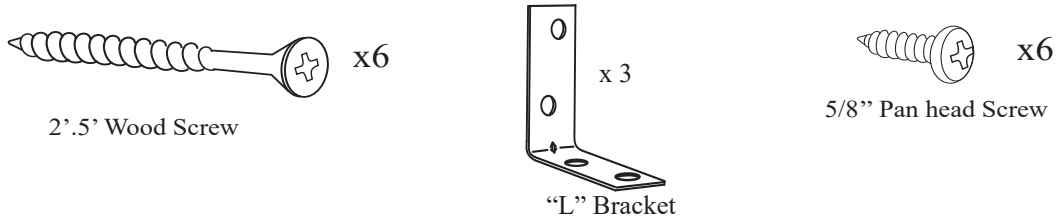

Step 7: Using a Stud Finder locate and mark the studs in your wall directly above the Bed Cabinet. Attach "L" brackets to the top, back of the Bed Cabinet using 5/8" Pan Head screws corresponding to where the studs are located in your wall. Now attach the "L" brackets to the studs in the wall using six 2.5" wood screws. See illustration 6

IMPORTANT! King and Queen size wall beds require 3 studs for proper anchoring. It is VERY important that the bed be anchored securely to the wall. If bed is not anchored properly the Bed Cabinet will fall causing SERIOUS injury. For technical support call 866-725-6401 toll free.

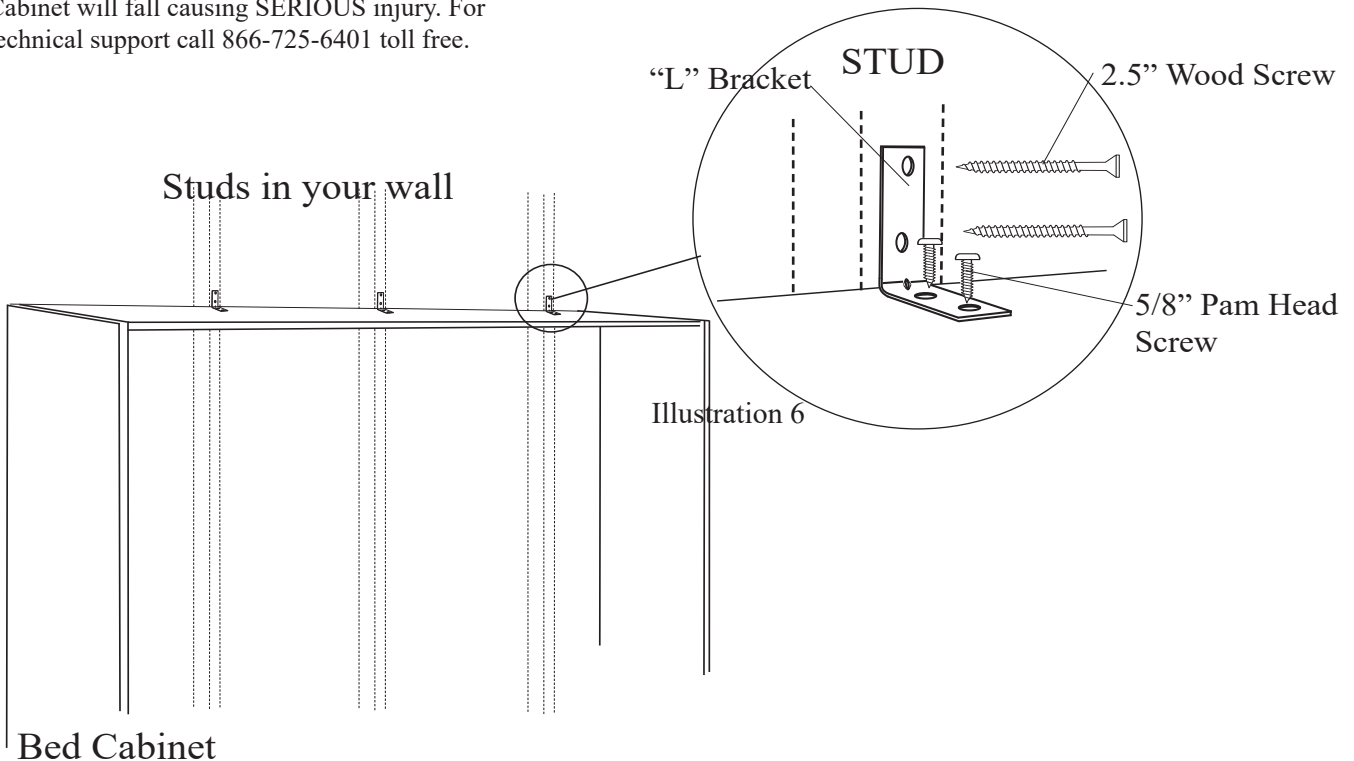

Important note: It is critical to orient the Bed Face panels and the Mattress Rails in the next 5 steps correctly. All of the renderings (drawings) in the next 5 steps assume that you are looking away from the wall you just installed the Bed Cabinet against in the previous step. There is a note under each of the following renderings indicating “your bed cabinet installed on this side” which indicates that is where the Bed Cabinet is in relation to the face panels and rails.

Step 8: Locate the Front Panel(s) and lay them on the floor FACE DOWN (finished side). Position them in front of where the Bed Cabinet was installed in the last step and leave enough room to work around them. Note that the holes for bed handles are arranged together and more away from the wall the Bed Cabinet is installed against.

Note: Number of face panels will vary depending on bed model. But will typically be either 2 or 4

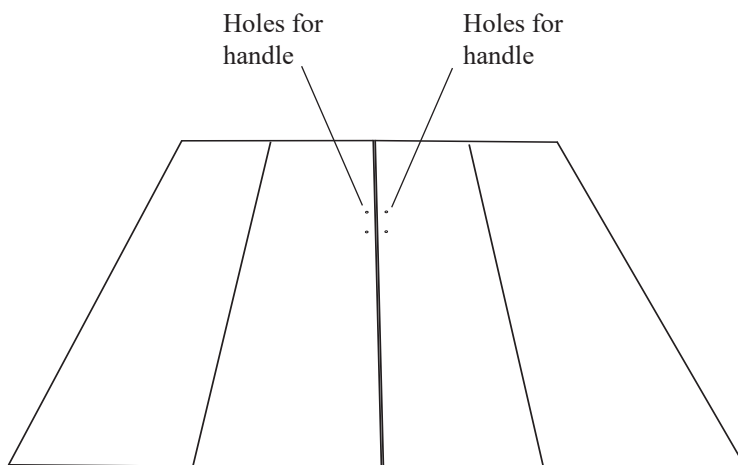

Your bed cabinet is installed on this side

Step 9: Arrange the Mattress Rails on the face panels as shown.

HELPFUL HINT: the “Head Rail” refers to the end that is closest to the Bed Cabinet during assembly and will be where your head is while sleeping.

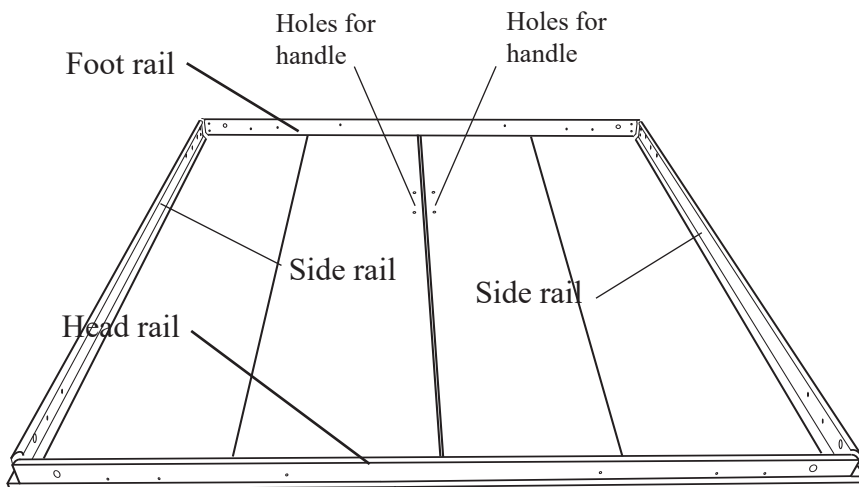

Your bed cabinet is installed on this side

Hardware needed for next 2 steps most from Pack #3

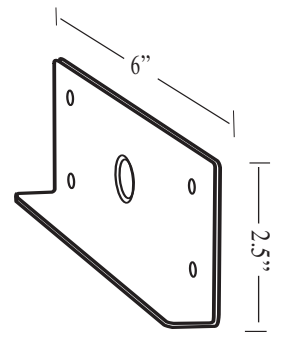
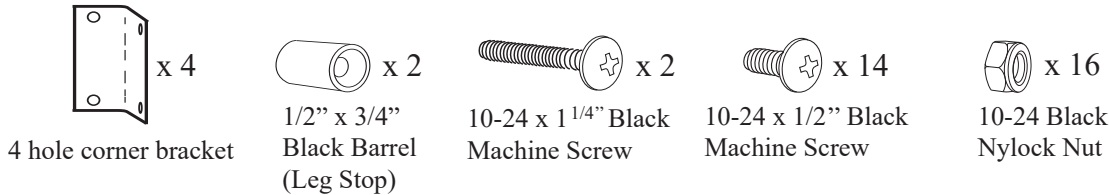

Panel Saver (From rails box)

Step 10: From hardware pack 3 locate the hardware shown above. Finger tighten the hardware as shown in illustration 7 connecting the Foot Rail to the Side Rail using the 4 hole corner bracket. Note the lower hole on each Side Rail uses the Leg Stop with the longer screw (1 1/4" Machine). Repeat step on the opposite side of the Foot Rail corner.

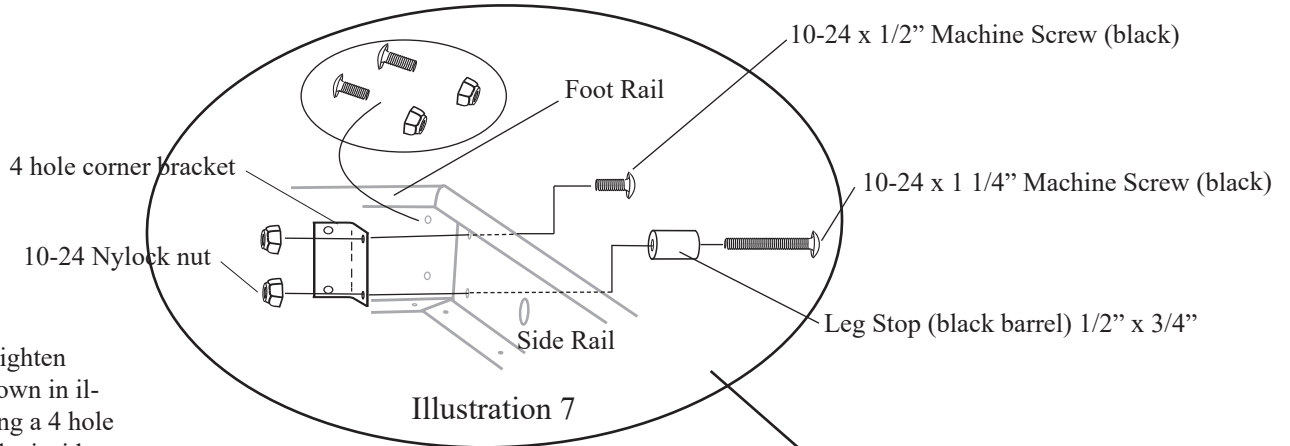

Step 11: Finger tighten the hardware as shown in illustration 8 attaching a 4 hole corner bracket on the inside of the Side Rail and the Panel Saver on the outside of the Side Rail. Now connect the Head Rail to the Side Rail via the 4 hole corner bracket and repeat on the opposite Head Rail corner.

Note: The Panel Savers have 4 holes but you will only use two attaching them to the Side Rails.

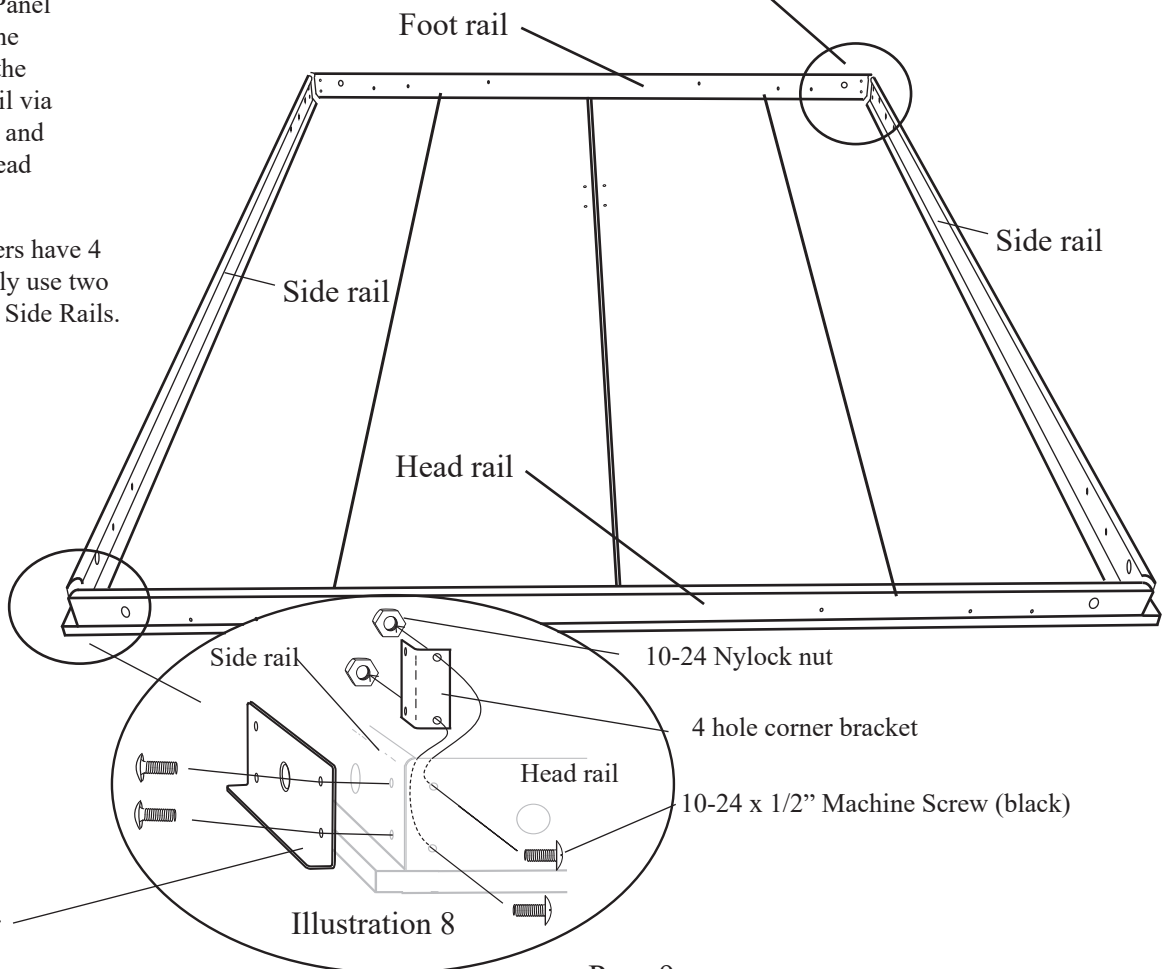

Step 12: Once all sides are finger tight go back to each corner and align the corners as they are tightened using either a socket or wrench and a Phillips screw driver.

Hardware and parts needed for next steps

 x 160
5/8" Square Pan head screw
(Hardware pack #7)

 x 1
Square Tip Bit
(Provided in Manila Envelope)

Step 13: Center the assembled Mattress Frame side to side on the Face Panels (leaving approximately 1" space on either side) and bring the Head Rail flush to the end of the Face Panels. Once the frame is positioned correctly and the panels and rails are even and square to each other use 2 screws (5/8" square drive) in each corner, 1 in each panel's Head and Foot rail, and 1 in the middle of each Side Rail as illustrated to hold assembly in place. With the rails held in place, Use the 5/8" screws in each of the remaining holes around the frame.

Caution: DO NOT STRIP SCREW!

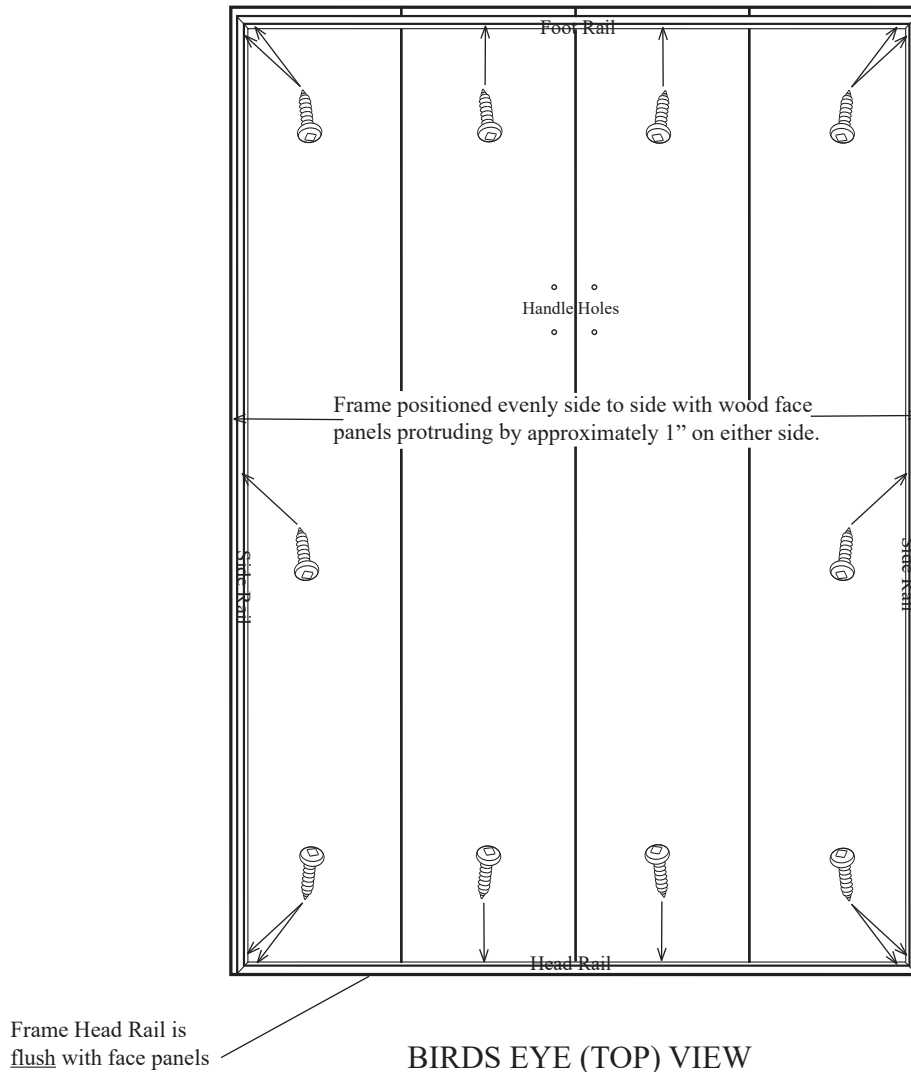

Hardware and parts needed for next steps

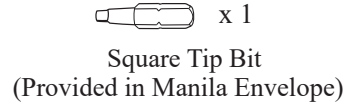
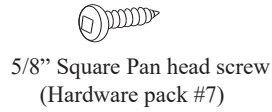
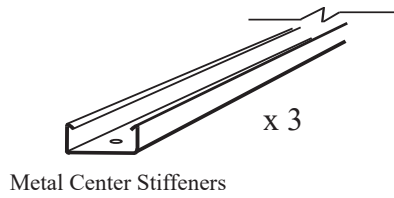

Step 14: Position the 3 Metal Stiffeners evenly in the space provided between the Head and Foot Rails as illustrated below. Now use the 5/8" square drive screws to fasten the Stiffeners to the Face Panels using all provided holes in the Stiffeners. **DO NOT STRIP SCREWS.**

Note: Occasionally one of the holes in the Center Stiffeners will be positioned where the seam of the face panels come together. In this case you do not need to put a screw in where it will wedge between two panels.

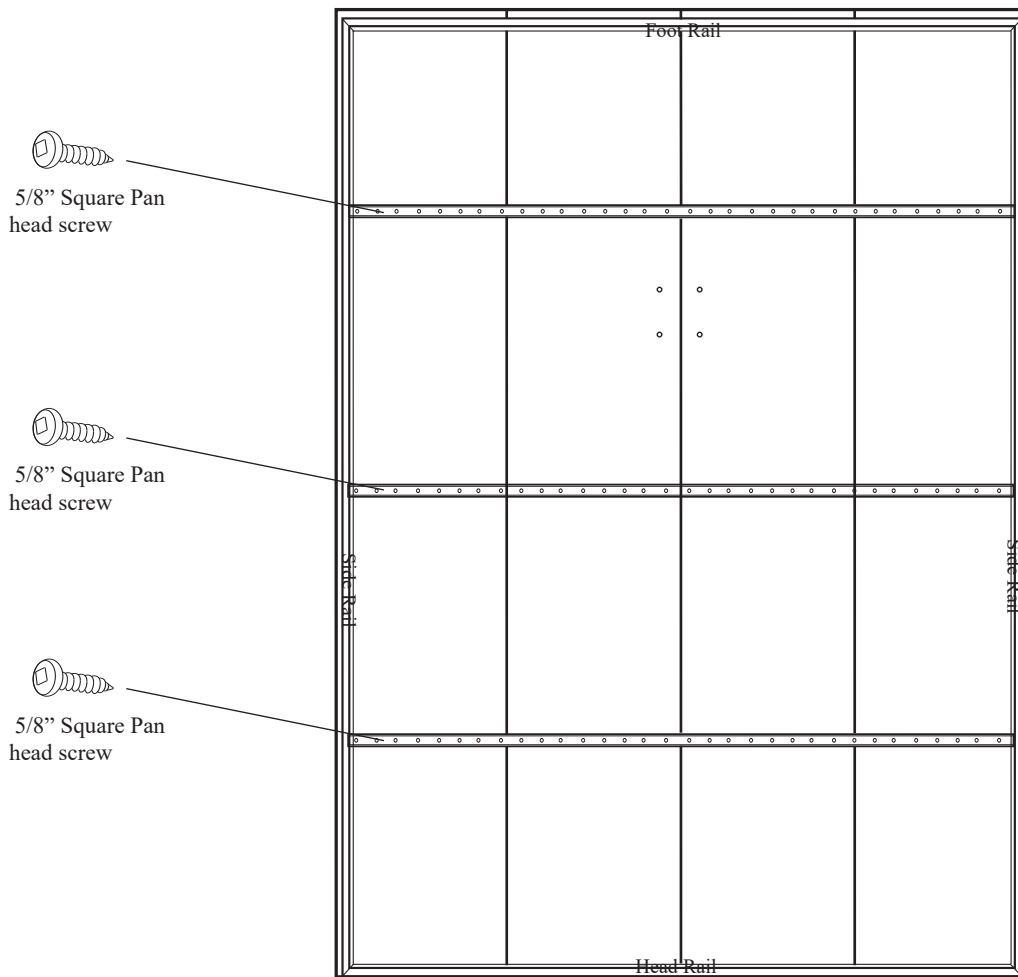

BIRDS EYE (TOP) VIEW

Hardware and parts needed for next steps

 x 1
 Square Tip Bit
 (Provided in Manila Envelope)

 x 2
 3/4" Washer (pack #5)

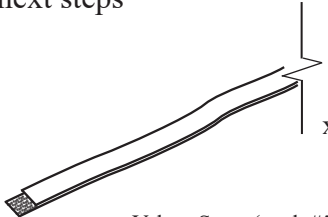
 x 1
 Velcro Strap (pack #5)

Step 15: Attach the Velcro Strap that is used for holding the mattress in place while wall bed is closed. First remove one of the 5/8" Pan head screws that attaches the rail to the Face Panels on each Side Rail of the frame at about 18" from the Foot Rail of the frame. Then put the removed screw through the 3/4" Washer. Position the end of the Velcro over the vacated screw hole on the rail and drive the screw through the Velcro strap and back into the hole. Repeat the process on the opposite Side Rail making sure that the Velcro Straps oppose each other so they hook together in the middle.

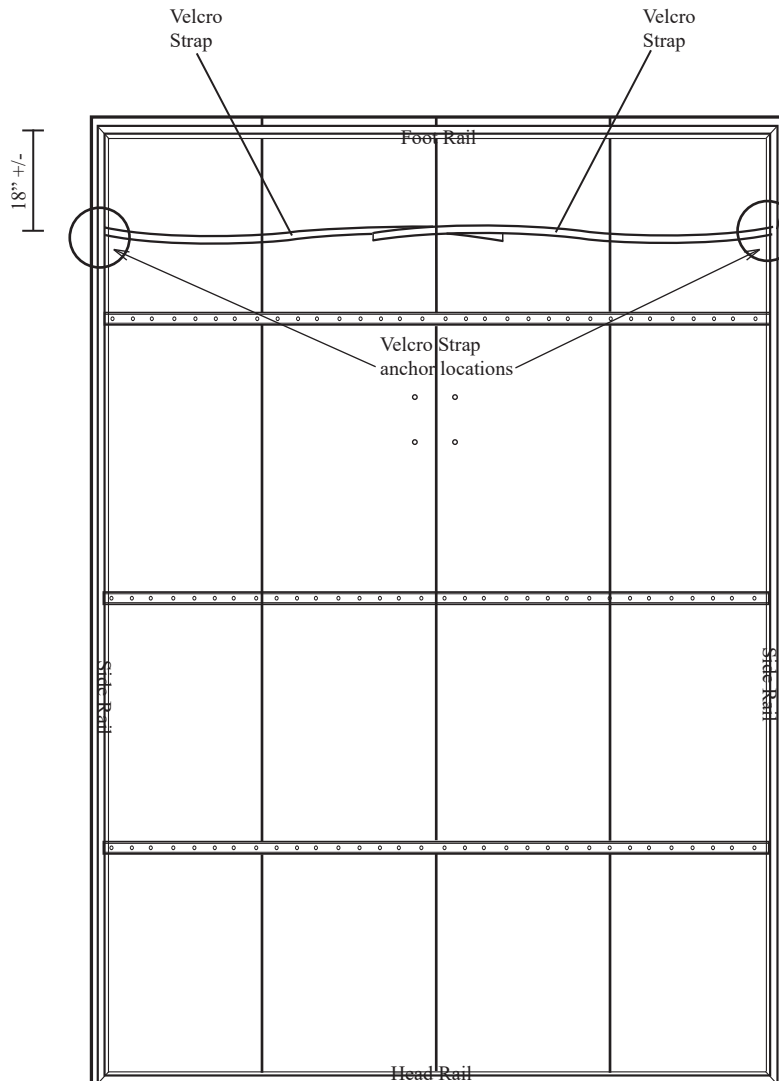
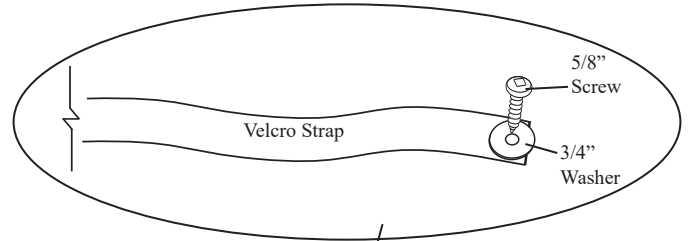

BIRDS EYE (TOP) VIEW

Hardware needed for next step from hardware pack #2

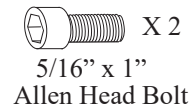
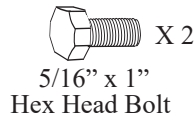
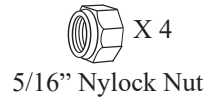

Step 16: As illustrated below, insert the Allen Head Bolt through bolt hole # 1 and tighten it down securely using a Nylock Nut. Now insert a 5/16" x 1" Hex Head bolt through hole # 3 and thread the Nylock nut ONLY UNTIL THE NUT IS FLUSH WITH THE END OF THE BOLT. Bolt hole #2 will be used in a later step and is left open for now.

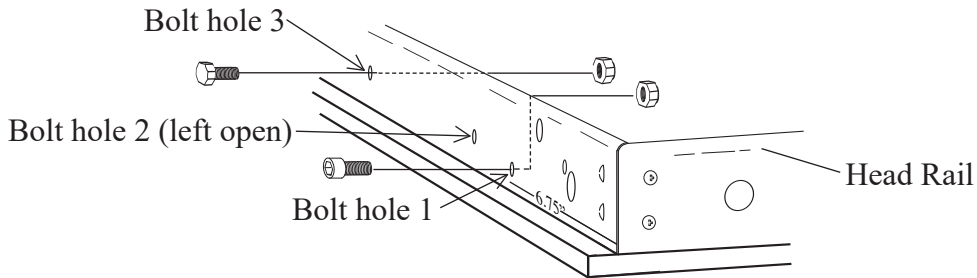

Hardware needed for next step from hardware pack #4

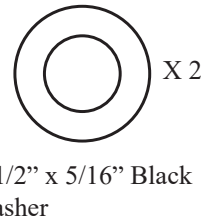
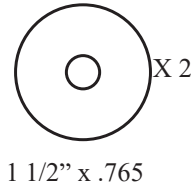
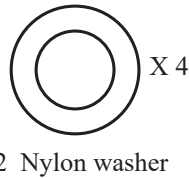
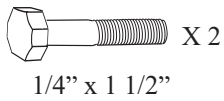

Step 17: Attach the Leg Assembly to the FOOT RAIL side of the frame as illustrated below. Use 1 Teflon washers on the out side of the frame for proper spacing.

Step 18: Position the Cross Bar between the Legs. Place the Star washer on one of the 1/4" X 1 1/2" Hex Head bolts. Repeat on other side.

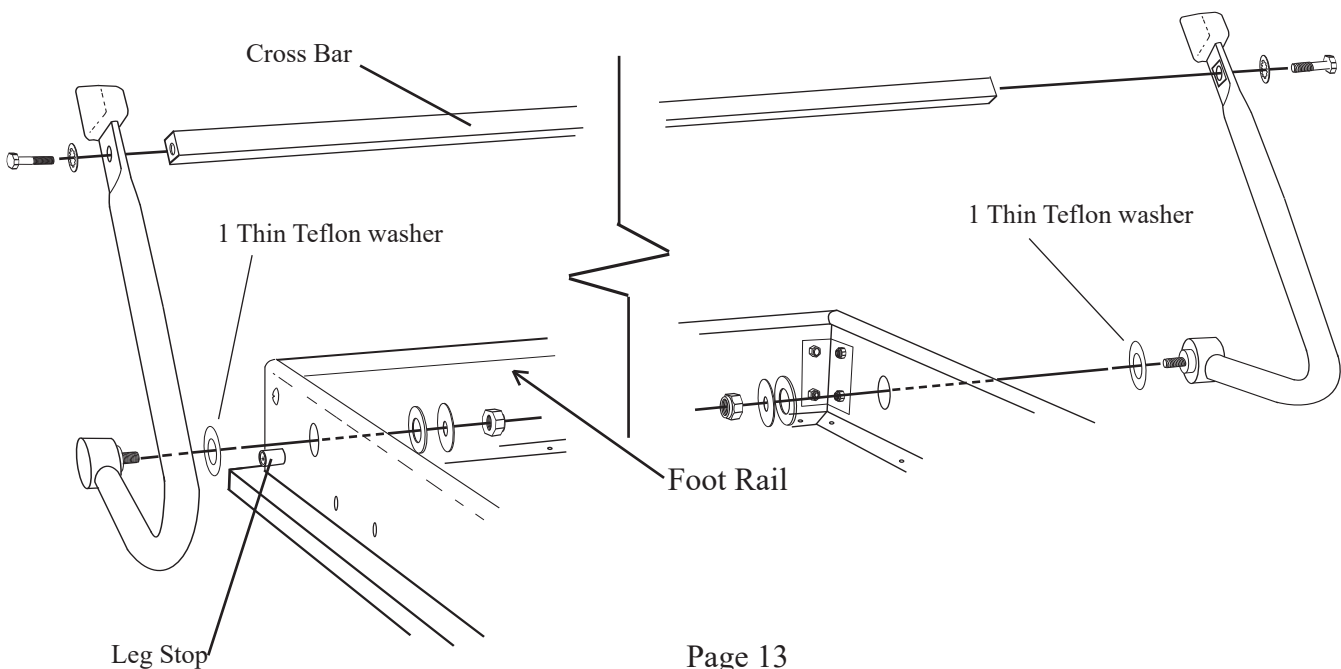



IF YOU PURCHASED LIGHTS FOR YOUR WALLBED YOU MUST RETURN TO THE LIGHT KIT INSTRUCTIONS STEP 6 AND INSTALL THE SAFETY CUT OFF DEVICE BEFORE MOVING ON.

WARNING: There is tremendous force involved in the next step, do not place hands between the front of the side boards and the tension arms as you set the mechanism.

Step 19: Brace one foot against the front edge of the Side Board and using the 14.5" black metal tubing provided in hardware kit, lever the Lift Mechanism's Tension Arm out and down until you can secure the Arm Lock onto the Hexagon Nut shown at right. BE SURE THAT THE LOCK IS SECURED AGAINST THE HEX NUT BEFORE RELEASING THE TENSION ON THE LIFT MECHANISM.

Helpful hint: As you start to draw the Tension Arm down with one hand, use the other hand to position the Arm Lock on top of the Hex Nut. Now as the Tension Arm continues to be pulled down with both hands, the Arm Lock will naturally drop into place around the Hex Nut as illustrated.

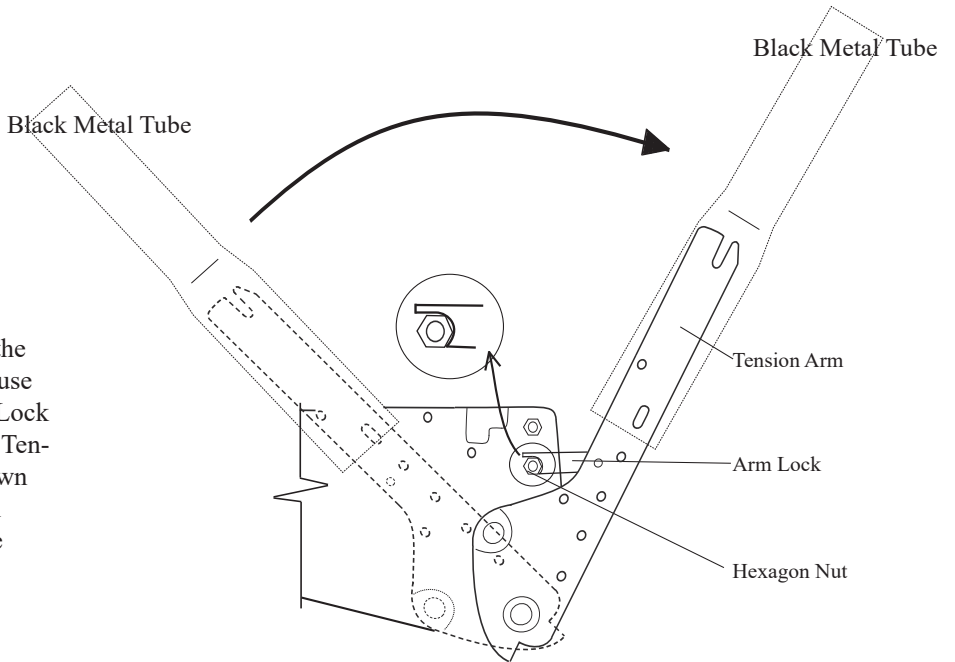

IMPORTANT! As instructed in step 16, Bolt #3 should be loose enough to slip into the notch at the end of the Tension Arm See illustration below.

Step 20: Stand the Bed face unit up on its Head Rail end. Now with you and your assistant on either side of the Bed face unit lift until the # 3 bolt on the Bed face unit is a few inches above the slotted end of the Tension Arm on both sides. Gently lower the Bed face unit between the Tension Arms and seat the # 3 bolt into the slot at the end of the Tension Arms. Now start pulling the bed face unit down and away from the Bed Cabinet the Allen Key bolt head will seat into the notch at the lower end of the Tension Arms. Lower the bed unit down and pull the Legs down so that they are on the floor. Someone will need to hold the bed unit down as it will want to rise.

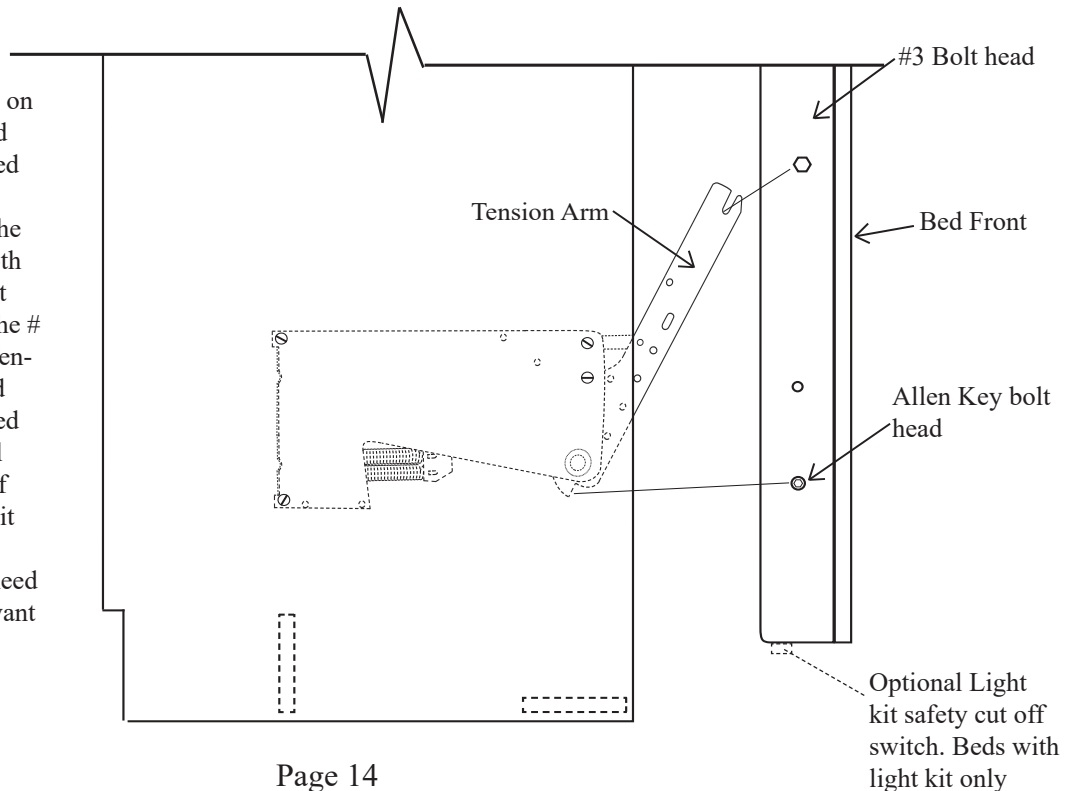

Hardware needed for next step from hardware pack #2

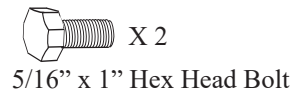

Warning very important step!

Step 21: Insert a 5/16" x 1" Hex Head bolt through hole #2 and tighten a 5/16" Nylock nut onto the bolt. Now tighten the nut and bolt in hole #3.

Repeat step 21 on the other side of the bed unit.

WARNING! Failure to insert and tighten all the bolts in step 21 could result in **severe personal injury** or damage to the lift mechanism. Lift mechanism damage caused by missing or loose hardware is not covered by warranty.

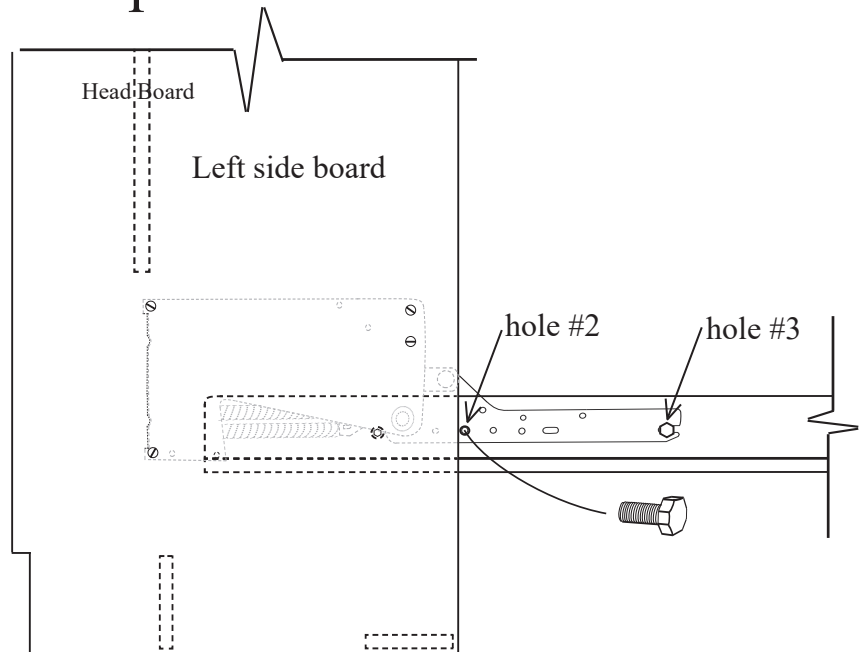

Hardware needed for next step from hardware pack #2

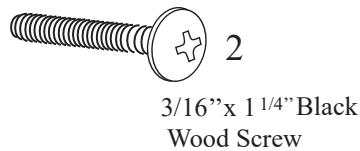

Step 22: Slip the Mechanism Cover over the Mechanism so that the tabs on the cover fit into the notches provided. Line up the hole with the barrel support and anchor in place using the 3/16" x 1 1/4" wood screw provided

Repeat step on the other Mechanism.

Helpful hint: The screw for attaching the spring cover is a wood screw not a machine screw and is in hardware pack #2.

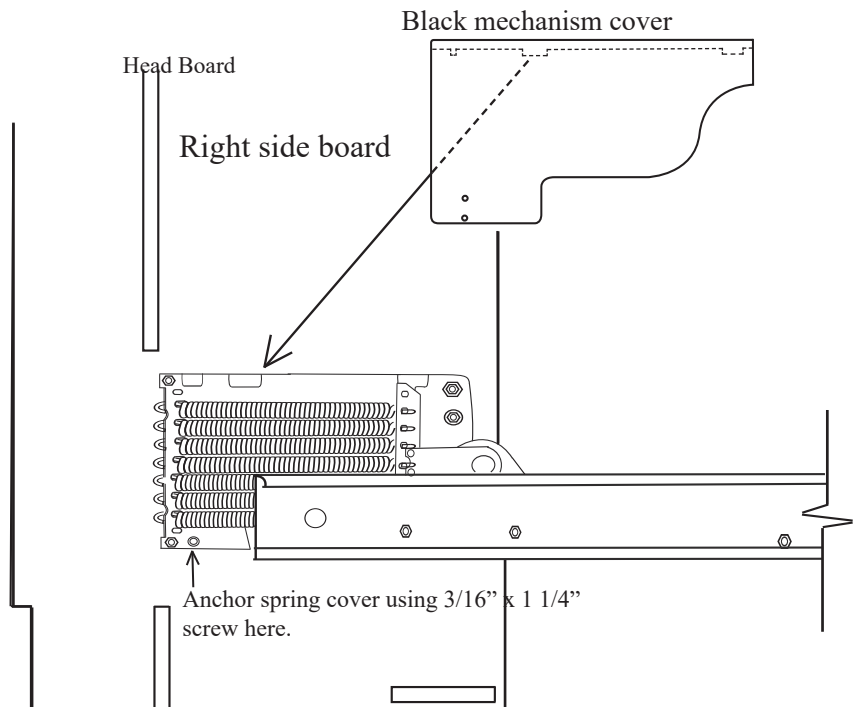

Step 23: When the bed is closed check to see if the gap on either side is the same. If it looks right skip this step. If the gap is not right, meaning that the Bed Box is too close to the side board or even touching it at the top on one side it will need to be adjusted. The procedure will require the bottom of the bed to be moved slightly to the left or right depending on which top corner is too close. If the Bed Face is too close on the top right side for instance, the right side (bottom) will need to be slid to the left slightly (See illustration 12). Have one person push the bed at the bottom with his feet while the second person pulls at the opposite bottom side.

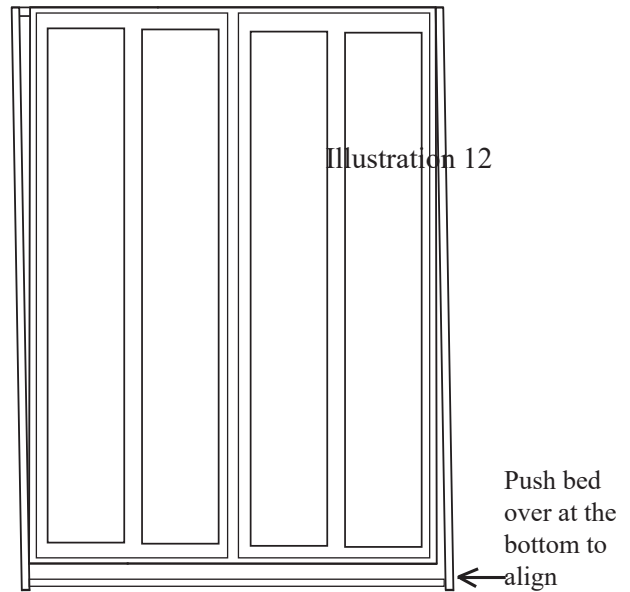

Step 24: Place the crown mold on the bed as illustrated and use the 1 1/4" screws to secure it in place. If you purchased side cabinets apply crown mold to them as well.

Note: Some bed models use a 3/4" thick (C shaped) flat piece as the crown mold.

Note: Dakota style bed does not have crown molding.

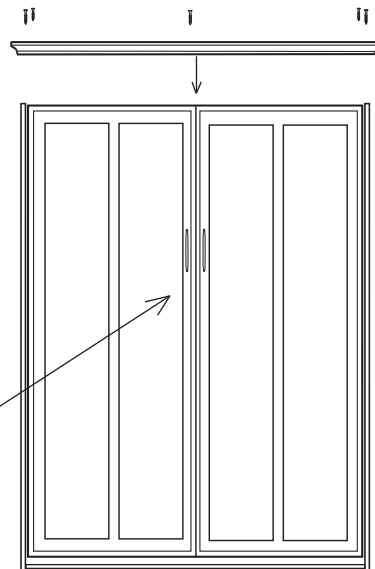

Step 25: Place handles on bed using pre-drilled holes in face panels.

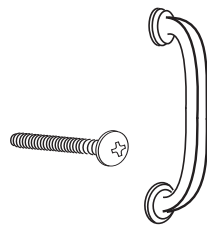

Step 26: Anchor the Side Cabinet to the Bed by first pre-drilling three 3/16" holes at the inside edge of the side cabinet. Position the holes close to the front edge of the Side Cabinet. One hole should be near the top, one should be inside the drawer area (remove drawer from cabinet to get to this one), and the third should be at the bottom (open door if your cabinet has door, or remove drawer at bottom) for this hole. Now move the side cabinets next to the bed and use three 1 1/4" Screws (located in a drawer or on a shelf of the side cabinet) through pre-drilled holes to anchor Side Cabinets to the Bed.

